

Notes

1. HEAD STYLE: DOME HEAD
2. SCREW TYPE: TENSION CONTRON BOLT
3. BOLT MATEIAL: A325
4. WASHER MATERIAL: F436
5. WASHER FINISH: PLAIN

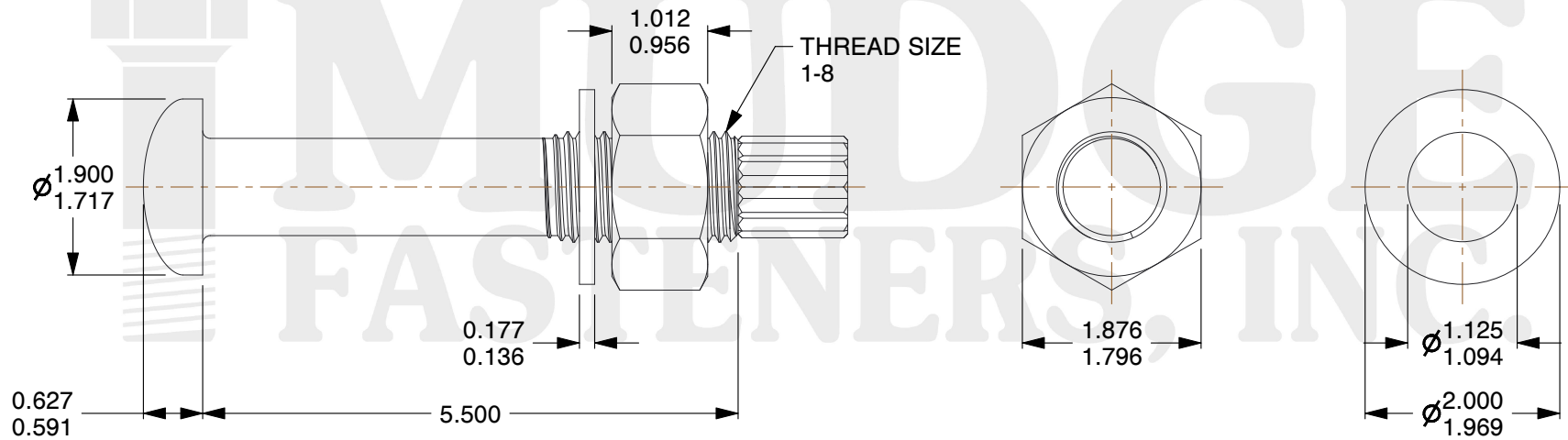
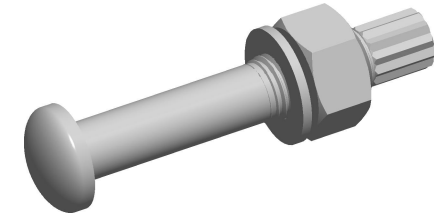

www.mudgefasteners.com

This file and any associated information and specifications are provided for reference and evaluation purposes only and are subject to change without notice. Mudge Fasteners makes no representations, warranties, or guarantees as to the appropriateness, accuracy, completeness, or suitability for any purpose of the file, information, or specification. You are solely responsible for the use of the file, information, and specifications.

This drawing is the property of Mudge Fasteners. It contains confidential proprietary information that is Mudge Fasteners property. Do not disclose to or duplicate for others except as authorized by Mudge Fasteners.

COMPONENT DESCRIPTION	1-8X5-1/2 DOME A325 TENSION CONTROL BOLT ASSEMBLED W/DH NUTS & F436 WASHERS PLAIN	UNIT
		INCH
PART NUMBER	217100C0550PN	SHEET
		1 of 1
MATERIAL	A325	SCALE
		0.553