

Notes :

1. HEAD STYLE: HEX HEAD
2. SCREW TYPE: BOLT
3. STANDARD: ANSI B18.2.1
4. MATERIAL: 18-8 STAINLESS STEEL

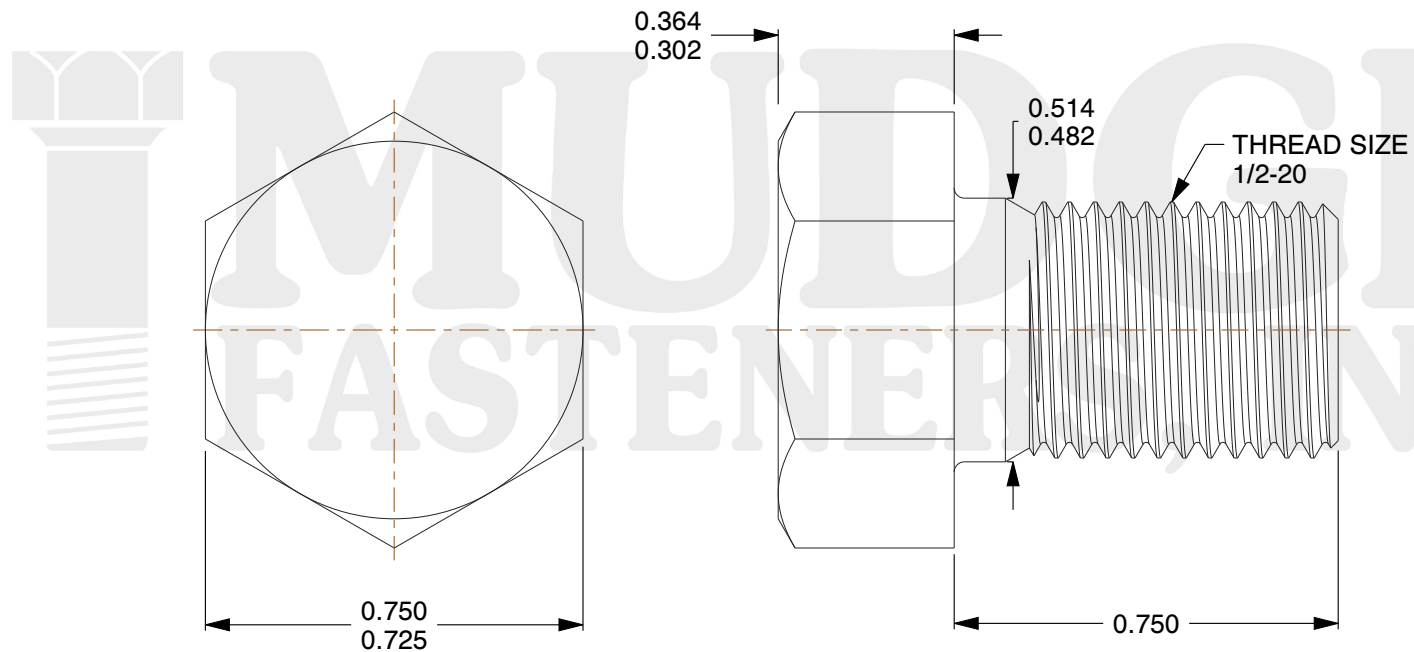
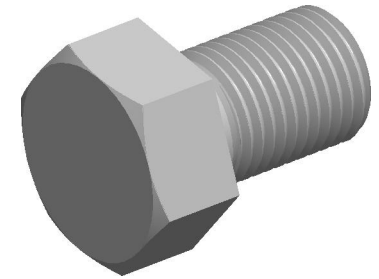

www.mudgefasteners.com

This file and any associated information and specifications are provided for reference and evaluation purposes only and are subject to change without notice. Mudge Fasteners makes no representations, warranties, or guarantees as to the appropriateness, accuracy, completeness, or suitability for any purpose of the file, information, or specification. You are solely responsible for the use of the file, information, and specifications.

This drawing is the property of Mudge Fasteners. It contains confidential proprietary information that is Mudge Fasteners property. Do not disclose to or duplicate for others except as authorized by Mudge Fasteners.

COMPONENT DESCRIPTION	1/2-20X 3/4 HEX BOLT STAINLESS STEEL	UNIT
		INCH
PART NUMBER	201050F075SS	SHEET
		1 of 1
MATERIAL	18-8 STAINLESS STEEL	SCALE
		2.667