

Notes

1. THREAD TYPE: FINE THREAD
2. SCREW TYPE: DRYWALL SCREW
3. MATERIAL: CARBON STEEL
4. STANDARD: ANSI B18.6.1

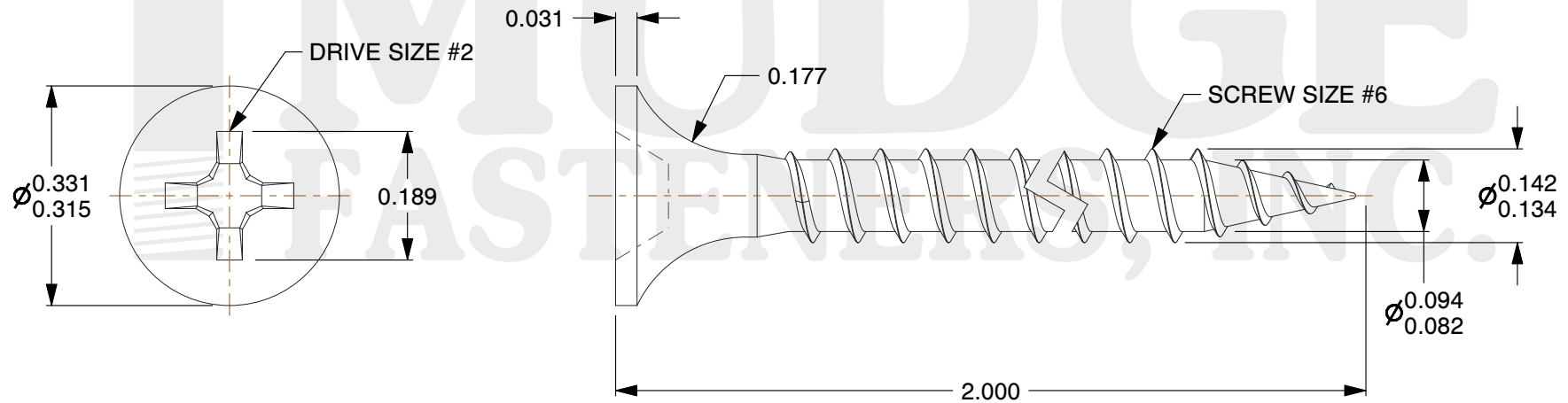
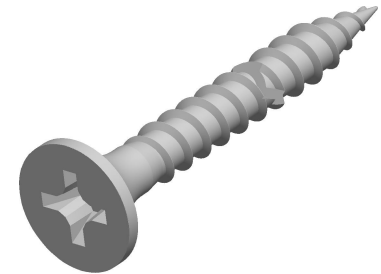

www.mudgefasteners.com

This file and any associated information and specifications are provided for reference and evaluation purposes only and are subject to change without notice. Mudge Fasteners makes no representations, warranties, or guarantees as to the appropriateness, accuracy, completeness, or suitability for any purpose of the file, information, or specification. You are solely responsible for the use of the file, information, and specifications.

This drawing is the property of Mudge Fasteners. It contains confidential proprietary information that is Mudge Fasteners property. Do not disclose to or duplicate for others except as authorized by Mudge Fasteners.

COMPONENT DESCRIPTION	6 X 2 DRYWALL SCREW FINE THREAD	UNIT
		INCH
		SHEET
PART NUMBER	16006200	1 of 1
MATERIAL	CARBON STEEL	SCALE
		3.999